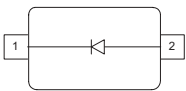
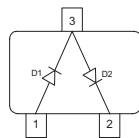
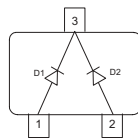
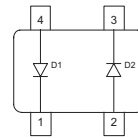
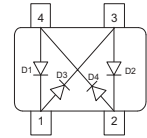
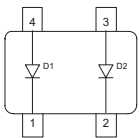
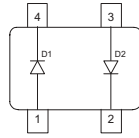

Silicon Schottky Diodes

- Low barrier type for DBS mixer applications up to 12 GHz, phase detectors and modulators
- Low noise figure
- Also available in TSSLP-2-1 for Application up to 24 GHz
- Pb-free (RoHS compliant) package ¹⁾
- Qualified according AEC Q101

BAT15-02LRH
BAT15-03W

BAT15-04W

BAT15-05W

BAT15-099
BAT15-099LRH

BAT15-099R

BAT15-07LRH

BAT15-098LRH

ESD (Electrostatic discharge) sensitive device, observe handling precaution!

Type	Package	Configuration	L_S (nH)	Marking
BAT15-02LRH	TSLP-2-7	single, leadless	0.4	NP
BAT15-03W	SOD323	single	1.8	P white
BAT15-04W	SOT323	series	1.4	S8s
BAT15-05W	SOT323	common cathode	1.4	S5s
BAT15-07LRH	TSLP-4-7	parallel pair, leadless	0.4	NP
BAT15-098LRH	TSLP-4-7	anti-parallel pair, leadless	0.4	B
BAT15-099	SOT143	anti-parallel pair	2	S5s
BAT15-099R	SOT143	cross-over ring	2	S6s
BAT15-099LRH	TSLP-4-7	anti-parallel pair, leadless	0.4	S5

¹⁾Pb-containing package may be available upon special request

Maximum Ratings at $T_A = 25^\circ\text{C}$, unless otherwise specified

Parameter	Symbol	Value	Unit
Diode reverse voltage	V_R	4	V
Forward current	I_F	110	mA
Total power dissipation	P_{tot}		mW
BAT15-02LRH, -07LRH, $T_S \leq 76^\circ\text{C}$		100	
BAT15-03W, $T_S \leq 70^\circ\text{C}$		100	
BAT15-04W, $T_S \leq 68^\circ\text{C}$		100	
BAT15-05W, $T_S \leq 65^\circ\text{C}$		100	
BAT15-099, $T_S \leq 48^\circ\text{C}$		100	
BAT15-099R, $T_S \leq 67^\circ\text{C}$		100	
BAT15-098LRH, -099LRH $T_S \leq 76^\circ\text{C}$		100	
Junction temperature	T_j	150	°C
Operating temperature range	T_{op}	-55 ... 150	
Storage temperature	T_{stg}	-55 ... 150	

Thermal Resistance

Parameter	Symbol	Value	Unit
Junction - soldering point ¹⁾	R_{thJS}		K/W
BAT15-02LRH, BAT15-07LRH		≤ 780	
BAT15-03W		≤ 795	
BAT15-04W		≤ 820	
BAT15-05W		≤ 850	
BAT15-099		≤ 1020	
BAT15-099R		≤ 830	
BAT15-098LRH, BAT15-099LRH		≤ 780	

¹⁾For calculation of R_{thJA} please refer to Application Note Thermal Resistance

Electrical Characteristics at $T_A = 25^\circ\text{C}$, unless otherwise specified

Parameter	Symbol	Values			Unit
		min.	typ.	max.	
DC Characteristics					
Breakdown voltage $I_{(BR)} = 100 \mu\text{A}$	$V_{(BR)}$	4	-	-	V
Forward voltage $I_F = 1 \text{ mA}$ $I_F = 10 \text{ mA}$	V_F	0.16 0.25	0.23 0.32	0.32 0.41	
Forward voltage matching ¹⁾ $I_F = 10 \text{ mA}$	ΔV_F	-	-	20	mV

AC Characteristics

Diode capacitance $V_R = 0 \text{ V}$, $f = 1 \text{ MHz}$, all other types $V_R = 0 \text{ V}$, $f = 1 \text{ MHz}$, BAT15-099R	C_T	- -	- -	0.35 0.5	pF
Differential forward resistance $I_F = 10 \text{ mA} / 50 \text{ mA}$	R_F	-	5.5	-	Ω

¹⁾ ΔV_F is the difference between lowest and highest V_F in a multiple diode component.

Diode capacitance $C_T = f(V_R)$

$f = 1\text{MHz}$

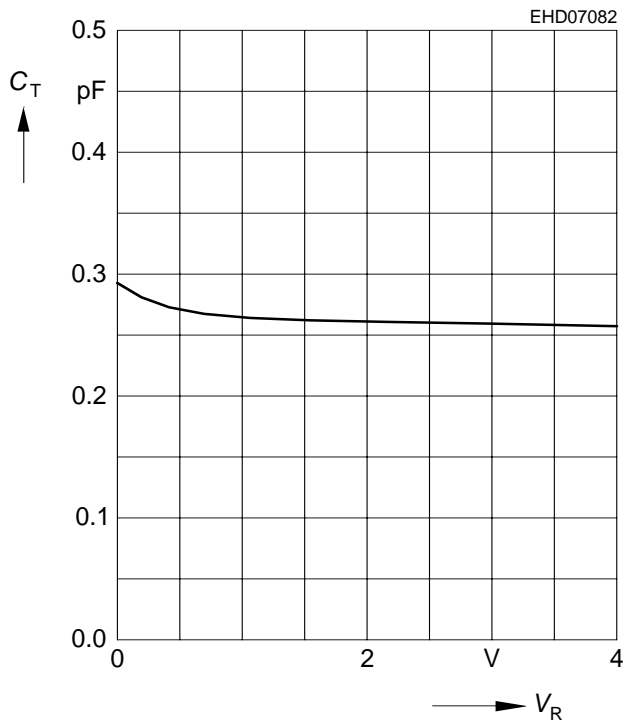

Reverse current $I_R = f(V_R)$

$T_A = \text{Parameter}$

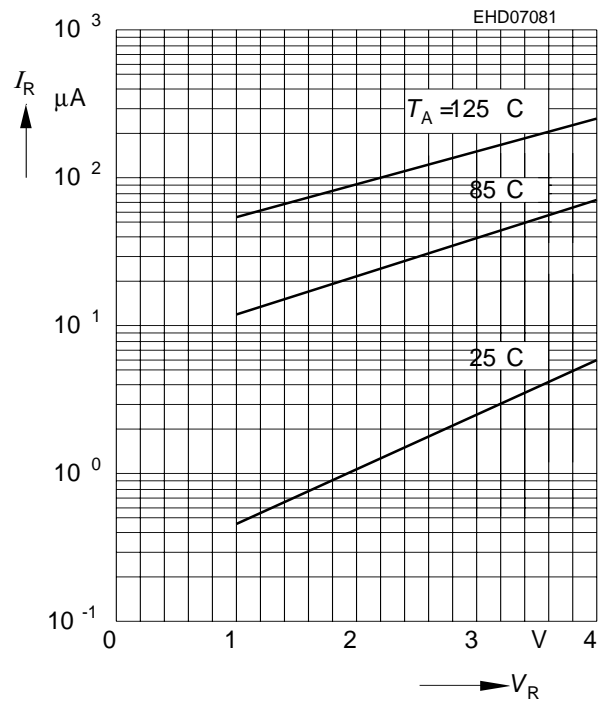

Forward current $I_F = f(V_F)$

$T_A = \text{Parameter}$

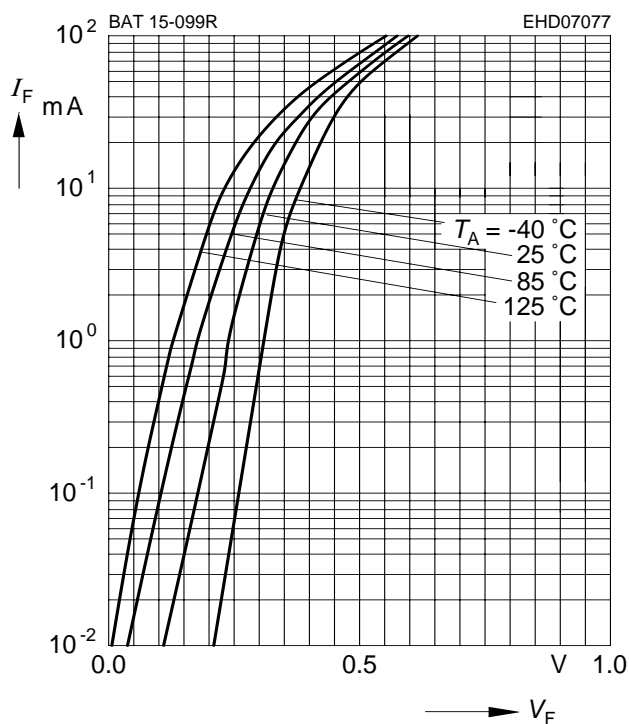

Forward current $I_F = f(T_S)$

BAT15-02LRH, BAT15-07LRH
BAT15-098LRH, BAT15-099LRH

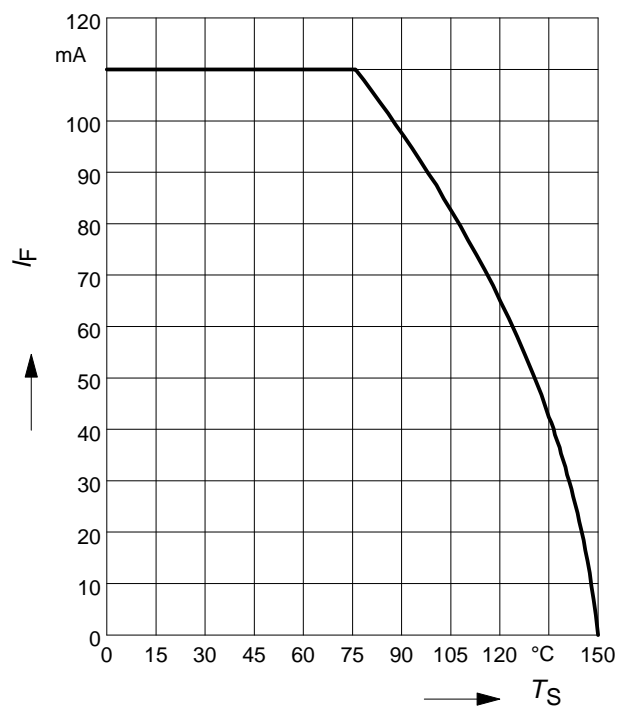

Forward current $I_F = f(T_S)$

BAT15-03W

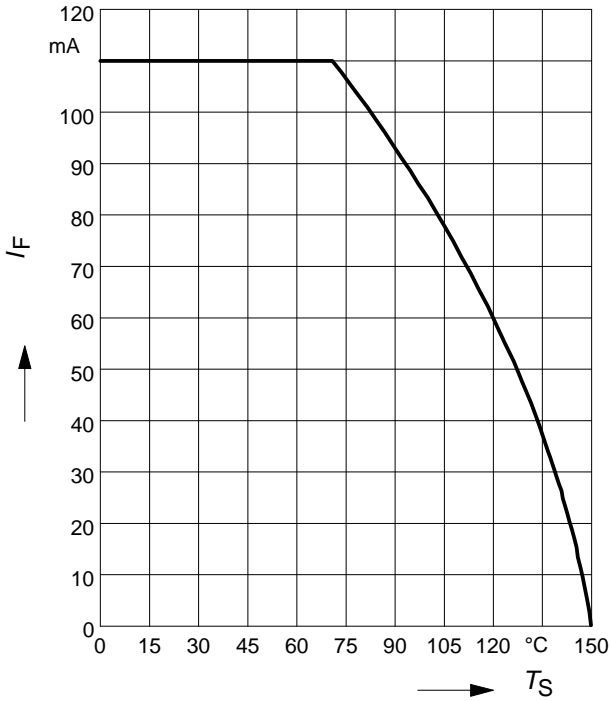

Forward current $I_F = f(T_S)$

BAT15-04W

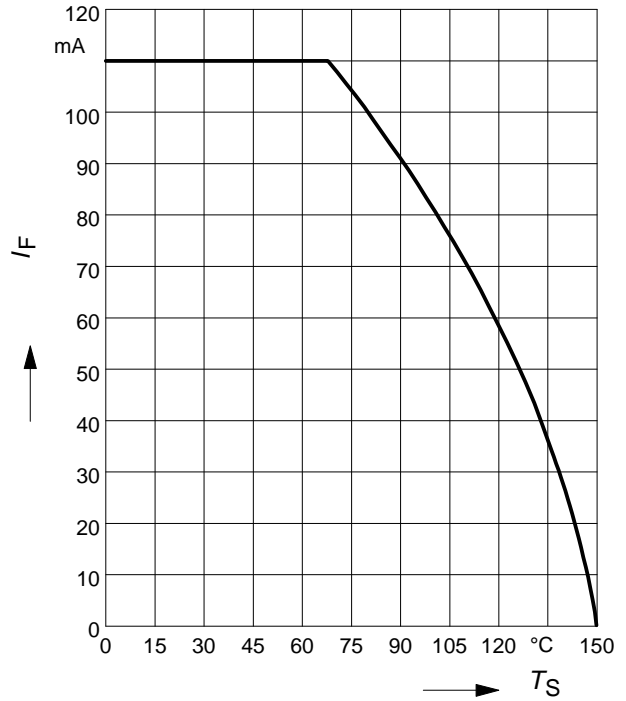

Forward current $I_F = f(T_S)$

BAT15-05W

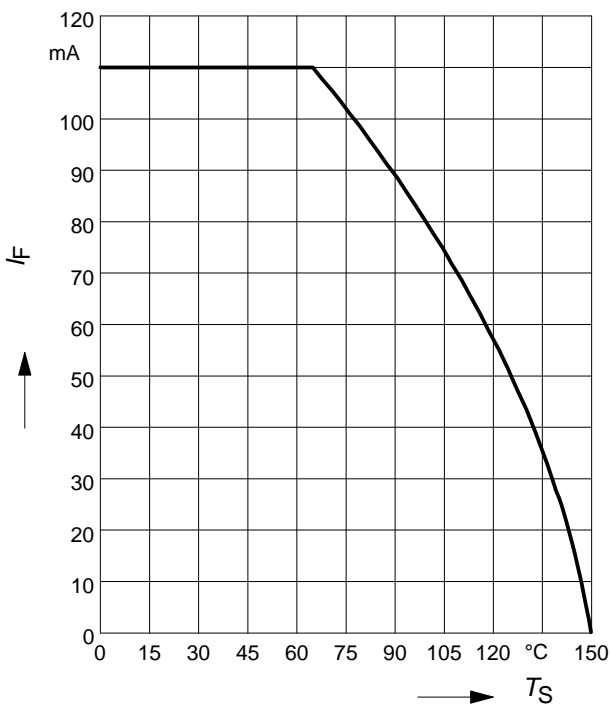

Forward current $I_F = f(T_S)$

BAT15-099

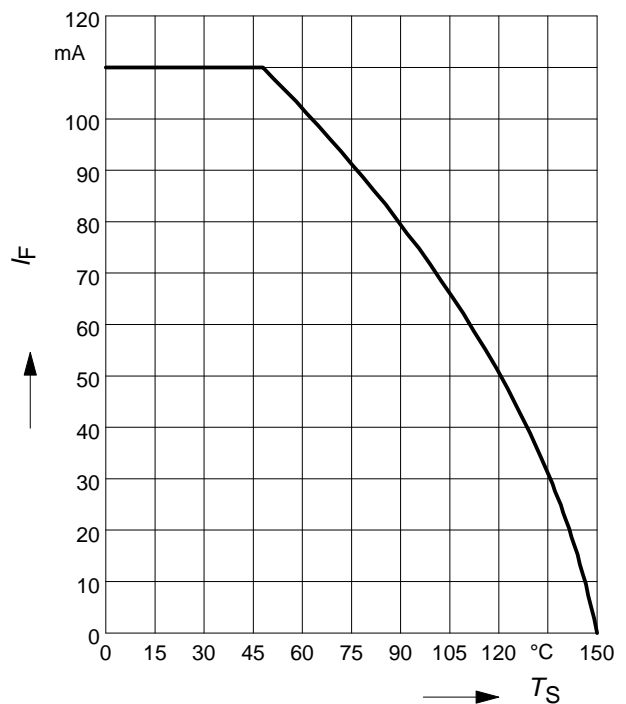

Forward current $I_F = f(T_S)$

BAT15-099R

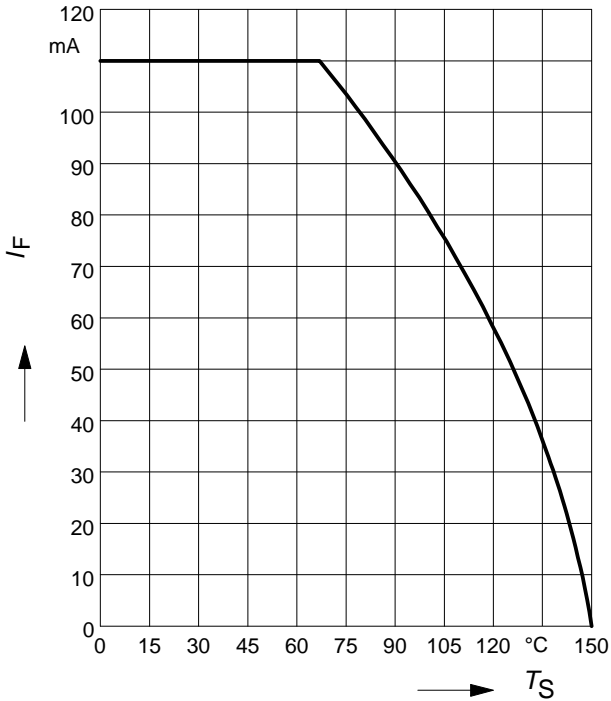

Permissible Puls Load $R_{thJS} = f(t_p)$

BAT15-02LRH, BAT15-07LRH

BAT15-098LRH, BAT15-099LRH

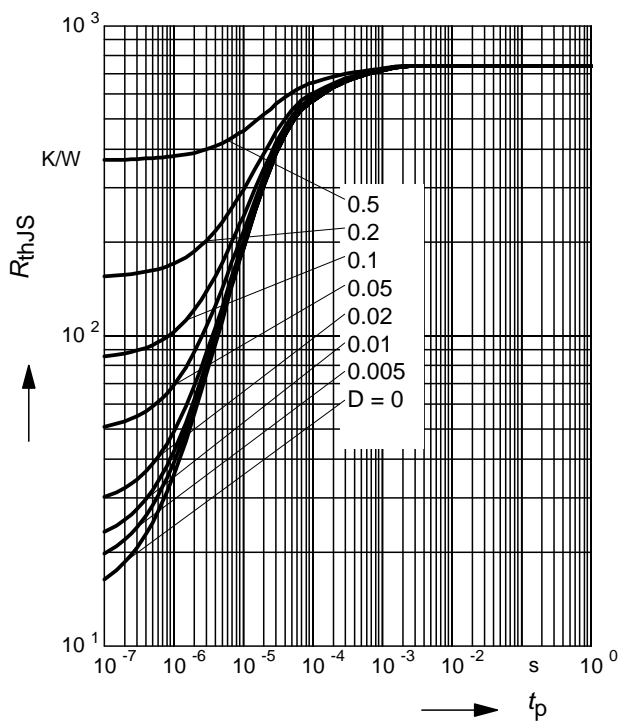

Permissible Pulse Load

$I_{Fmax}/I_{FDC} = f(t_p)$ BAT15-02LRH, -07LRH

BAT15-098LRH, BAT15-099LRH

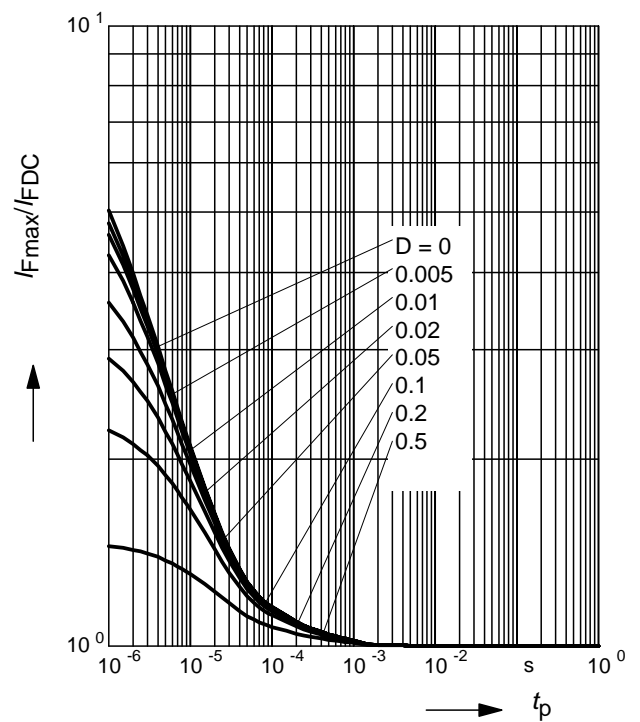

Permissible Puls Load $R_{thJS} = f(t_p)$

BAT15-03W

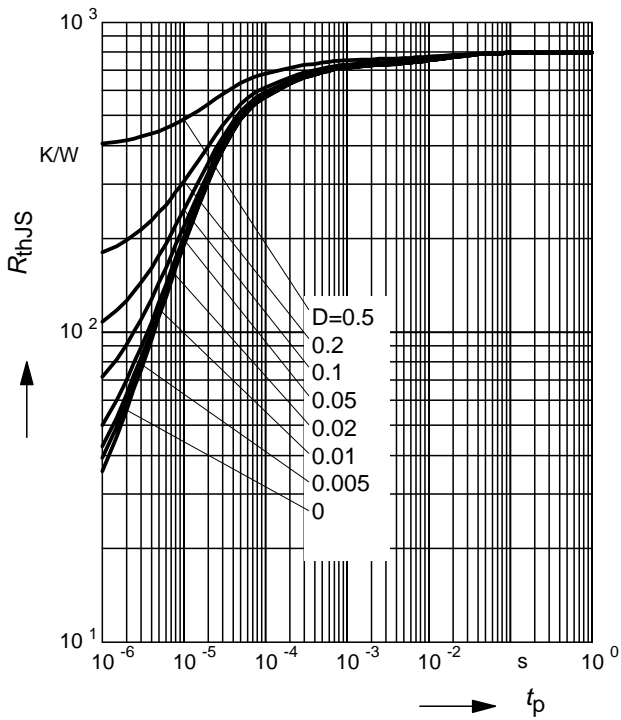

Permissible Pulse Load

$I_{Fmax} / I_{FDC} = f(t_p)$

BAT15-03W

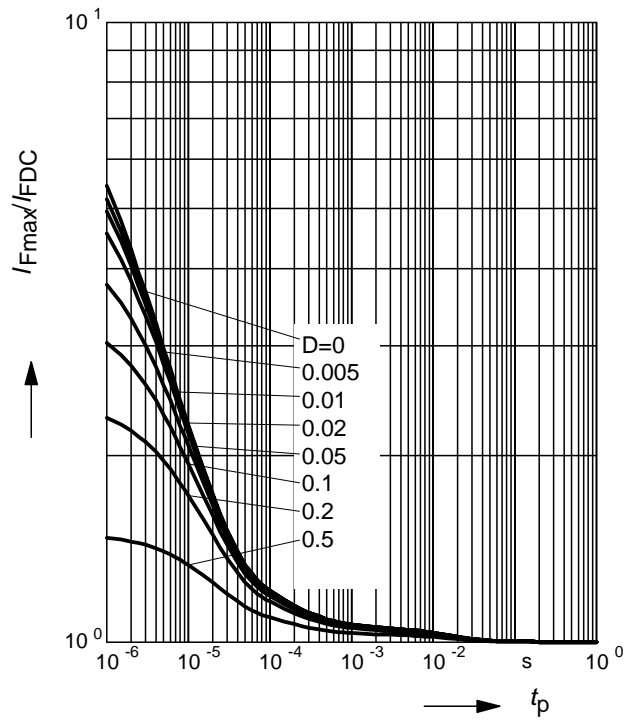

Permissible Puls Load $R_{thJS} = f(t_p)$

BAT15-04W

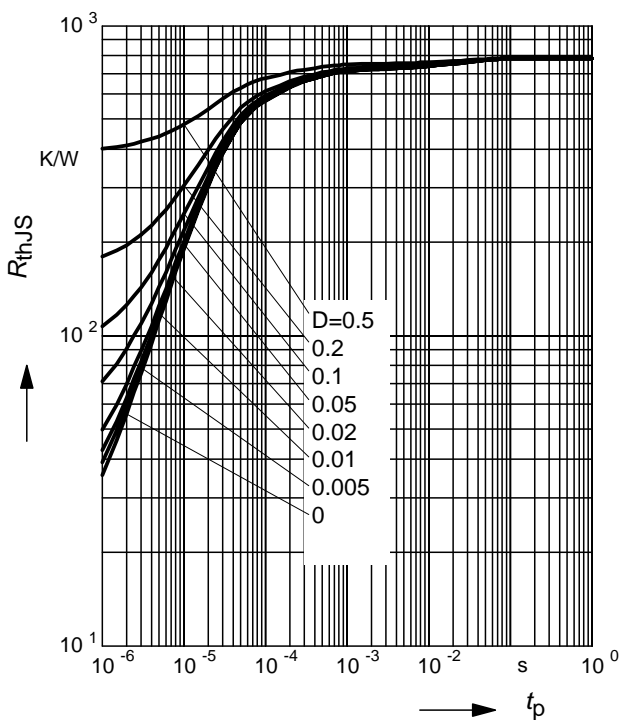

Permissible Pulse Load

$I_{Fmax} / I_{FDC} = f(t_p)$

BAT15-04W

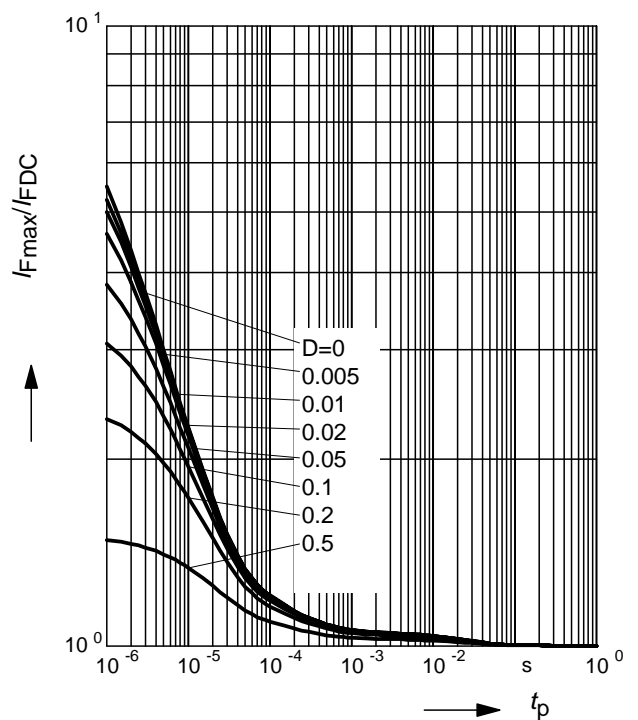

Permissible Puls Load $R_{thJS} = f(t_p)$

BAT15-05W

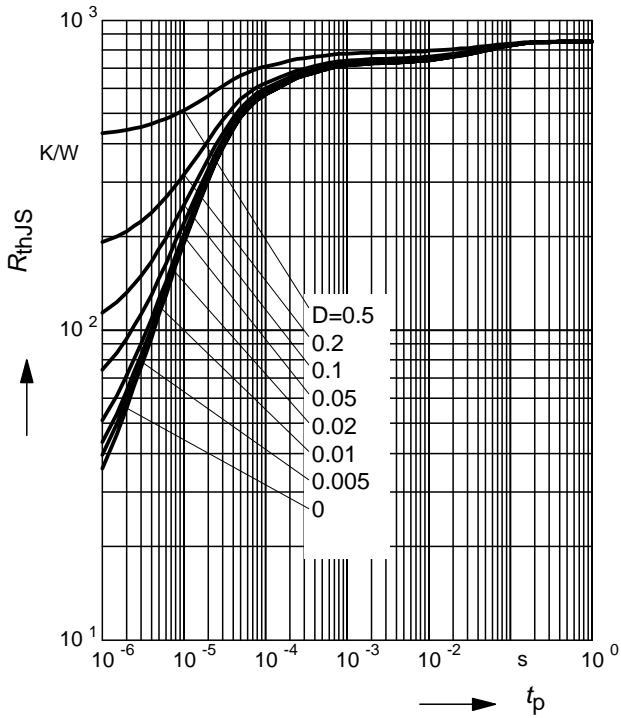

Permissible Pulse Load

$I_{Fmax} / I_{FDC} = f(t_p)$

BAT15-05W

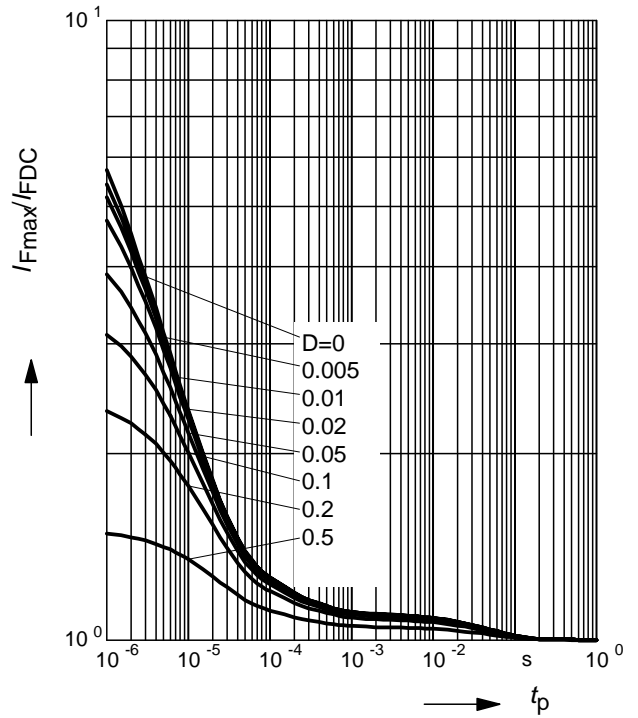

Permissible Puls Load $R_{thJS} = f(t_p)$

BAT15-099

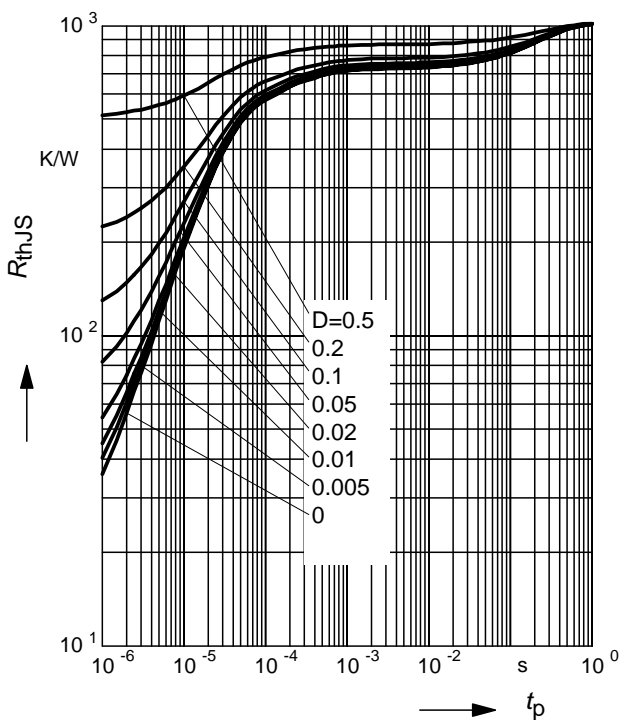

Permissible Pulse Load

$I_{Fmax} / I_{FDC} = f(t_p)$

BAT15-099

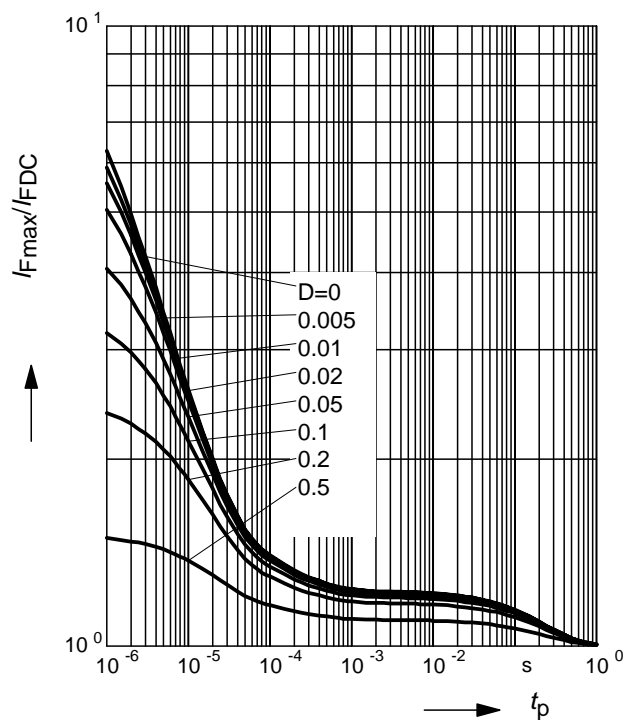

Permissible Puls Load $R_{thJS} = f(t_p)$

BAT15-099R

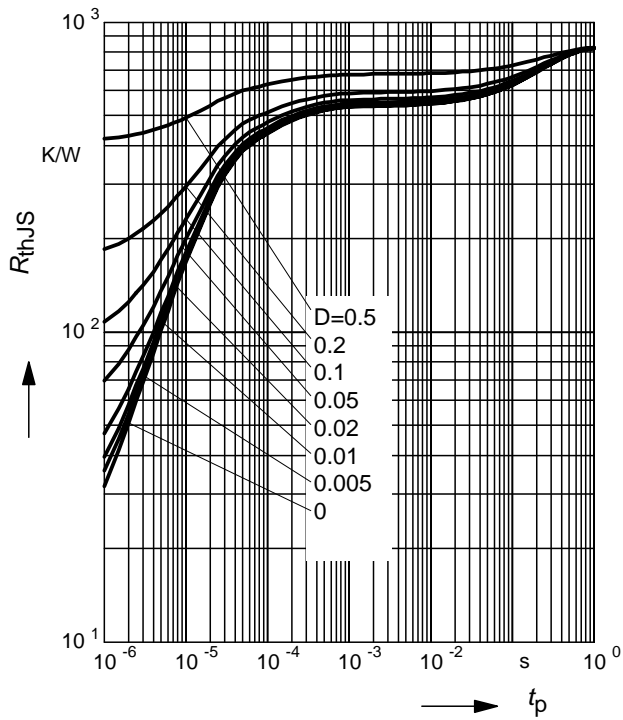

Permissible Pulse Load

$I_{Fmax} / I_{FDC} = f(t_p)$

BAT15-099R

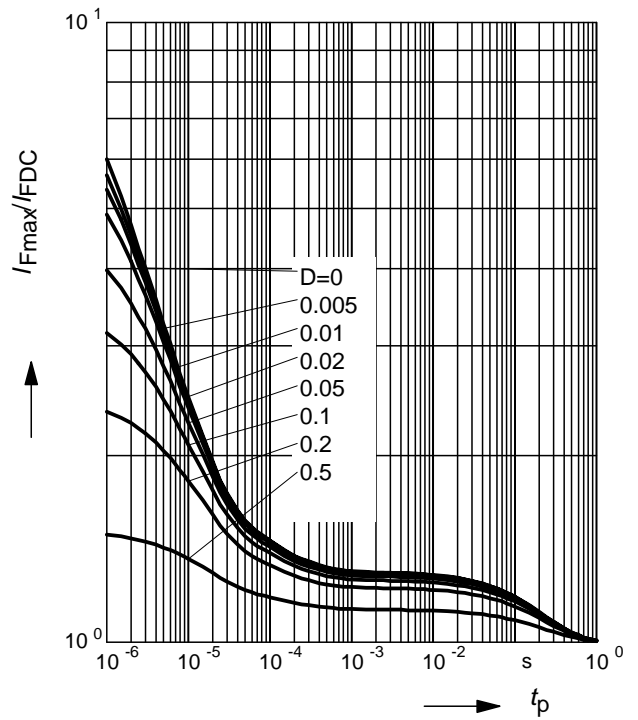

S₁₁-Parameters for BAT15-099

 Typical impedance characteristics (with external bias I and $Z_0 = 50\Omega$)

f	$I = 0.02 \text{ mA}$		$I = 0.05 \text{ mA}$		$I = 0.1 \text{ mA}$		$I = 0.2 \text{ mA}$		$I = 0.5 \text{ mA}$	
GHz	MAG	ANG	MAG	ANG	MAG	ANG	MAG	ANG	MAG	ANG
1	0.94	-16.4	0.84	-16.6	0.77	-16.4	0.59	-17.2	0.19	-16.7
2	0.93	-33.8	0.88	-33.8	0.77	-34.5	0.58	-35.2	0.15	-36.1
3	0.92	-53.8	0.86	-54.5	0.75	-54.1	0.58	-56.1	0.13	-64.8
4	0.91	-74.3	0.84	-75.3	0.72	-76.4	0.51	-78.4	0.11	-104.8
5	0.91	-96.6	0.84	-97.6	0.72	-99.1	0.53	-102.3	0.15	-135.7
6	0.91	-115.4	0.84	-116.7	0.73	-118.7	0.53	-122.9	0.18	-160.9
7	0.91	-131	0.84	-132.3	0.73	-134.1	0.54	-138.1	0.2	-168.8
8	0.91	-143	0.84	-144.5	0.73	-146.8	0.55	-150.5	0.81	179.4
9	0.91	-155.6	0.83	-150.2	0.71	-159.7	0.53	-163.9	0.18	179.4
10	0.9	-167.3	0.83	-169.7	0.71	-178.8	0.51	-175.8	0.14	151.2
11	0.89	175.5	0.8	172.6	0.7	170	0.45	164.9	0.09	105.5
12	0.88	175.5	0.76	146.5	0.62	142.8	0.39	134.2	0.14	43.6

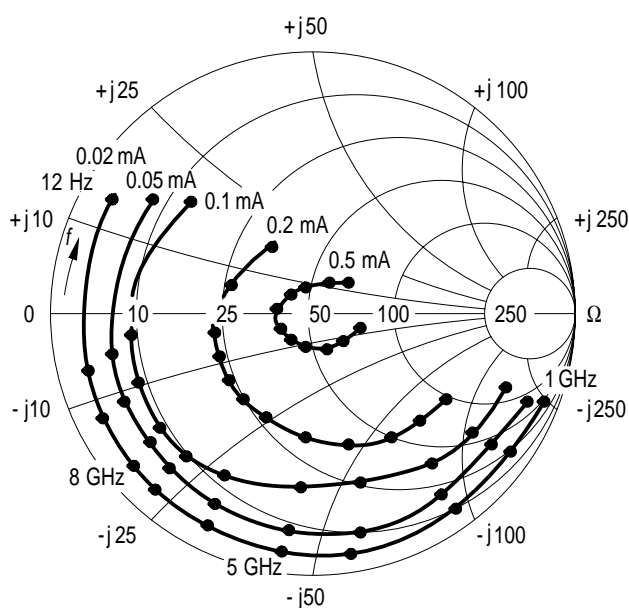
S₁₁ = (f, I) BAT15-099

EHD07083

Package Outline

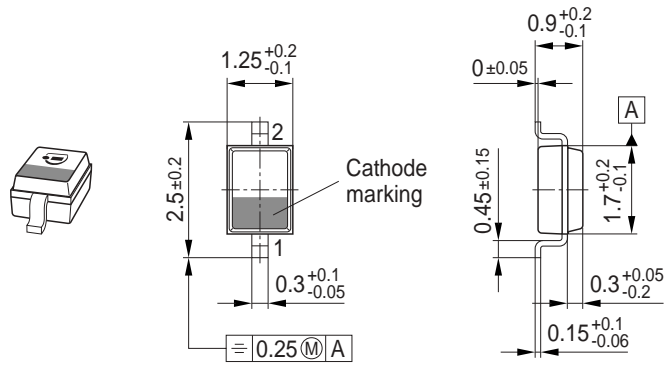

Foot Print

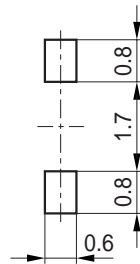

Marking Layout (Example)

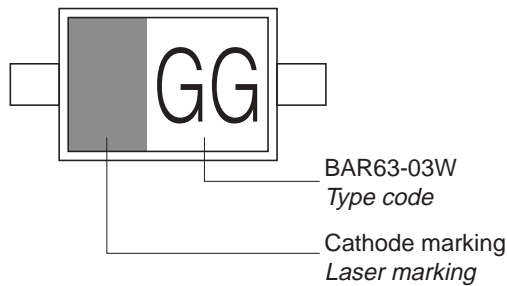

Standard Packing

Reel \varnothing 180 mm = 3.000 Pieces/Reel
 Reel \varnothing 330 mm = 10.000 Pieces/Reel

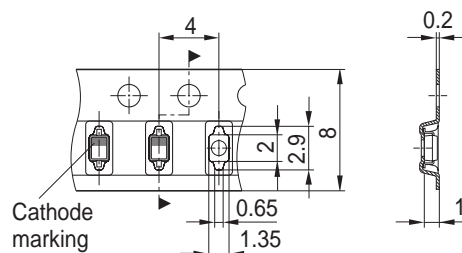

Package Outline

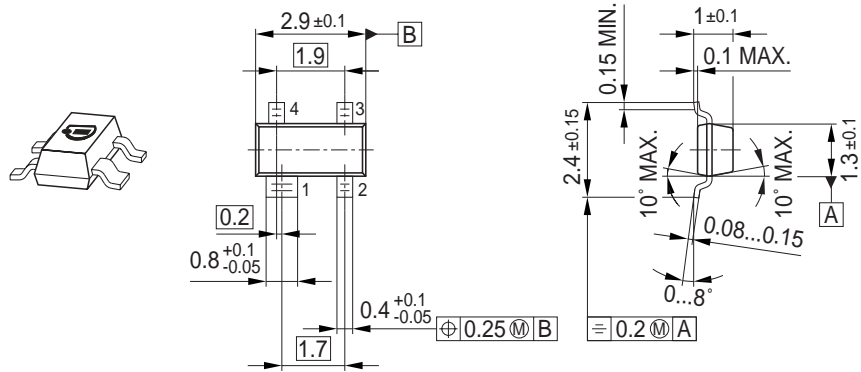

Foot Print

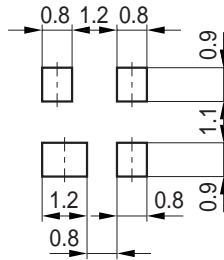

Marking Layout (Example)

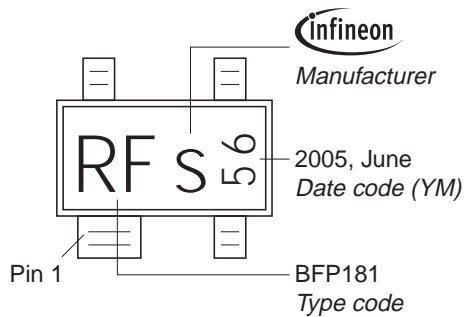

Standard Packing

Reel $\varnothing 180 \text{ mm} = 3.000 \text{ Pieces/Reel}$
 Reel $\varnothing 330 \text{ mm} = 10.000 \text{ Pieces/Reel}$

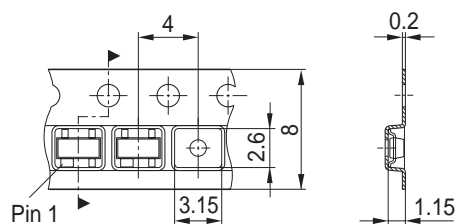

Package Outline

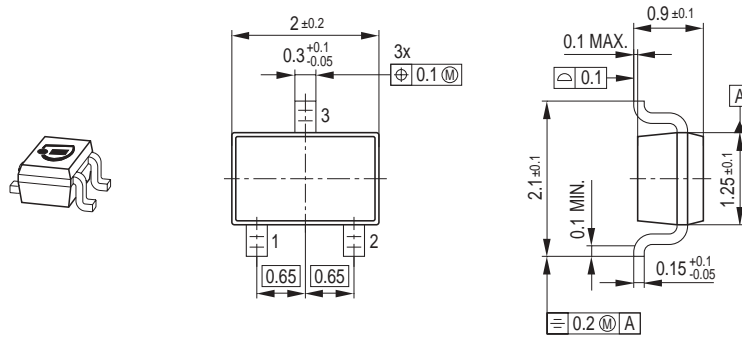

Foot Print

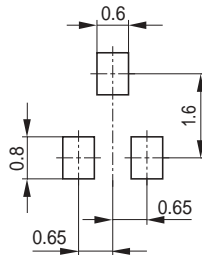

Marking Layout (Example)

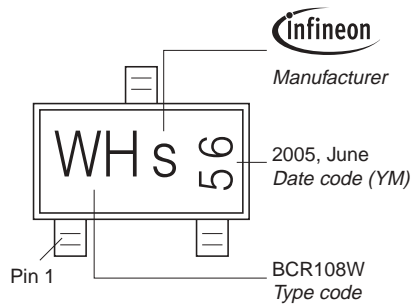

Standard Packing

Reel $\varnothing 180$ mm = 3.000 Pieces/Reel
 Reel $\varnothing 330$ mm = 10.000 Pieces/Reel

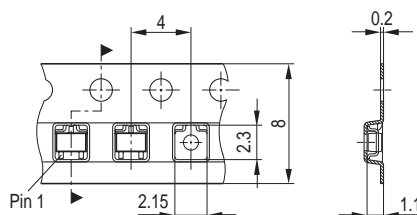

Package Outline

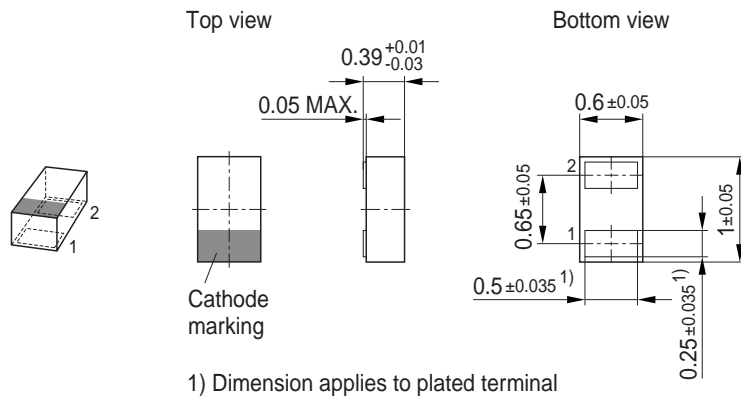

Foot Print

For board assembly information please refer to Infineon website "Packages"

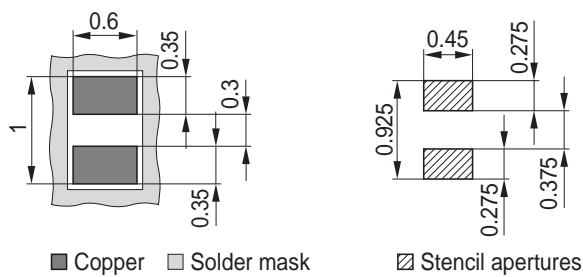

Marking Layout (Example)

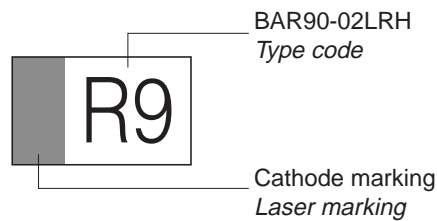

Standard Packing

Reel $\varnothing 180 \text{ mm} = 15.000 \text{ Pieces/Reel}$
 Reel $\varnothing 330 \text{ mm} = 50.000 \text{ Pieces/Reel (optional)}$

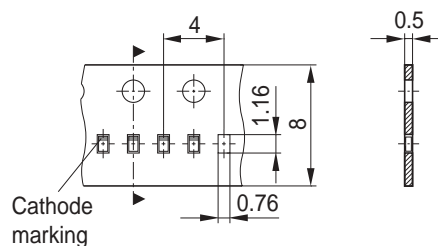

Package Outline

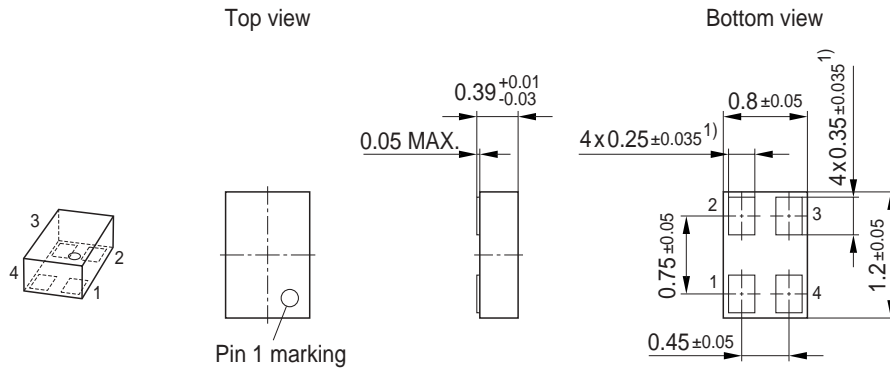

1) Dimension applies to plated terminal

Foot Print

For board assembly information please refer to Infineon website "Packages"

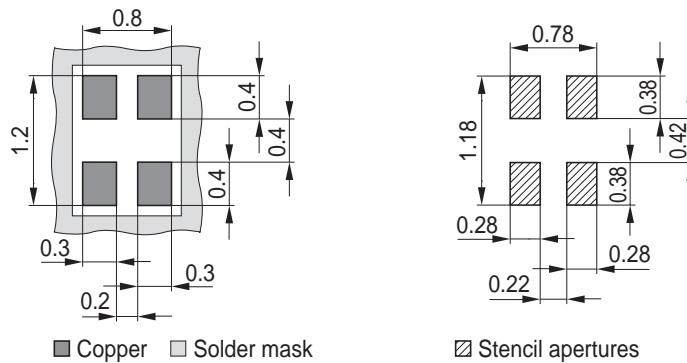

Marking Layout (Example)

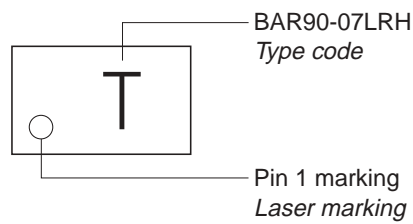

Standard Packing

Reel \varnothing 180 mm = 15.000 Pieces/Reel

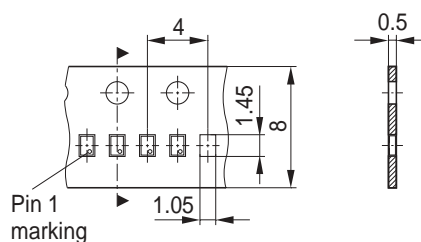

Edition 2006-02-01
Published by
Infineon Technologies AG
81726 München, Germany
© Infineon Technologies AG 2007.
All Rights Reserved.

Attention please!

The information given in this dokument shall in no event be regarded as a guarantee of conditions or characteristics ("Beschaffenheitsgarantie"). With respect to any examples or hints given herein, any typical values stated herein and/or any information regarding the application of the device, Infineon Technologies hereby disclaims any and all warranties and liabilities of any kind, including without limitation warranties of non-infringement of intellectual property rights of any third party.

Information

For further information on technology, delivery terms and conditions and prices please contact your nearest Infineon Technologies Office (www.infineon.com).

Warnings

Due to technical requirements components may contain dangerous substances. For information on the types in question please contact your nearest Infineon Technologies Office.

Infineon Technologies Components may only be used in life-support devices or systems with the express written approval of Infineon Technologies, if a failure of such components can reasonably be expected to cause the failure of that life-support device or system, or to affect the safety or effectiveness of that device or system.

Life support devices or systems are intended to be implanted in the human body, or to support and/or maintain and sustain and/or protect human life. If they fail, it is reasonable to assume that the health of the user or other persons may be endangered.